

GENESIS SHAFTWAY

PLANNING GUIDE



Shaftway vertical platform lift for lifting heights up to 14 feet

Please note:

Dimensions provided in this Guide are for **REFERENCE ONLY** and should not be used for site preparation or construction.

Genesis Shaftway Model Table of Contents

What is a Vertical Platform Lift?	4
Why a Vertical Platform Lift?	4
Design Assistance	4
Finishes	4
How it Works	5
Lifting Heights and Mast Sizes	6
Leadscrew Drive System	7
Hydraulic Drive System	8
Platforms	9
Platform Configurations	10
Operating Controls	11
Optional Features	13
Garaventa Style Doors and Gates	14
Fire Rated Doors and Frames	14
Door Locks	14
Garaventa Style Door Dimensions	15
Fire Rated Door Dimensions	19
Shaftway/Pit and Platform Clear Dimensions	23
Base Attachment	27
Mast Attachment	27
Leadscrew Drive System: Technical Reference	28
Hydraulic Drive System: Technical Reference	29
Genesis Loading Diagram	30
Force Reactions	31

What is a Vertical Platform Lift?

The Genesis Vertical Platform Lift is a cost effective way to transport a passenger in a wheelchair, or someone who has difficulty using stairs. The Genesis vertical platform lift provides a code compliant access solution for lifting heights of up to 4343mm (171") (check the regulations for your jurisdiction). With a variety of platform configurations, the Genesis is available as a 2 or 3 stop unit that can be operated independently or by an attendant. The Genesis is suitable for indoor or outdoor use and is available in a multitude of different colors and finishes so that it blends into any setting.

Why a Genesis Platform Lift?

Cost-effective

A Genesis vertical lift is more cost-effective than an elevator and does not require a machine room to house the electrical and mechanical components. In applications where usage is limited to people who have difficulty using stairs, a vertical lift may be the most appropriate solution.

Blends with Environment

The Genesis vertical lift is an attractive space saving alternative to a lengthy or winding ramp. Adjacent to stairs or in an area complimentary to your building, these lifts can be finished to compliment the aesthetics of the site.

Meets ADA Requirements (USA)

Vertical platform lifts are recognized in the ADA and A117.1 Accessibility Guidelines as a means to provide public building access. Genesis lifts exceed ASME A18.1 and CSA B355 requirements for platform lifts.

Design Assistance

With over 35 years of experience, Garaventa has the expertise to overcome almost any design challenge you face. Please call our Design Hot Line with your accessibility challenge.

1-800-663-6556 or +1-604-594-0422

Finishes

The standard finish is electrostatically applied and baked powder coat finish in Satin Grey for the steel panels and champagne anodized aluminum extrusions for the framework. As an option, these components can be painted from the large selection of RAL colors (a global paint color system).

Climate Controlled Shaftways

Typically, the Genesis Shaftway model is located in a shaftway that is indoors or otherwise climate-controlled.

When located in a shaftway that is not climate-controlled, the basic outdoor package and additional treatments for extreme conditions are included to enhance durability and reliable performance.

Included in the outdoor package are: hot dipped galvanized base, primed mezzanine brackets, sealed electrical box, rubber boots on switches and stainless steel fasteners.

How it Works

The Genesis vertical lift is offered in a variety of configurations and styles for different accessibility challenges. All versions of the Genesis vertical lift operate in the same manner and consists of a complete drive system, a platform with side walls, doors with an interlock system and call stations.

The mast houses the electrical and mechanical components that raise and lower the cantilevered

platform. The doors or gates cannot be opened unless the platform is at an appropriate landing. The platform is called to the landing by using the call stations located at each landing. Once at a landing, the door interlock is released and the door can be opened.

The Genesis vertical lift can be used to provide accessibility either indoors or outdoors and can be installed directly on the floor or in a 76mm (3") deep pit.

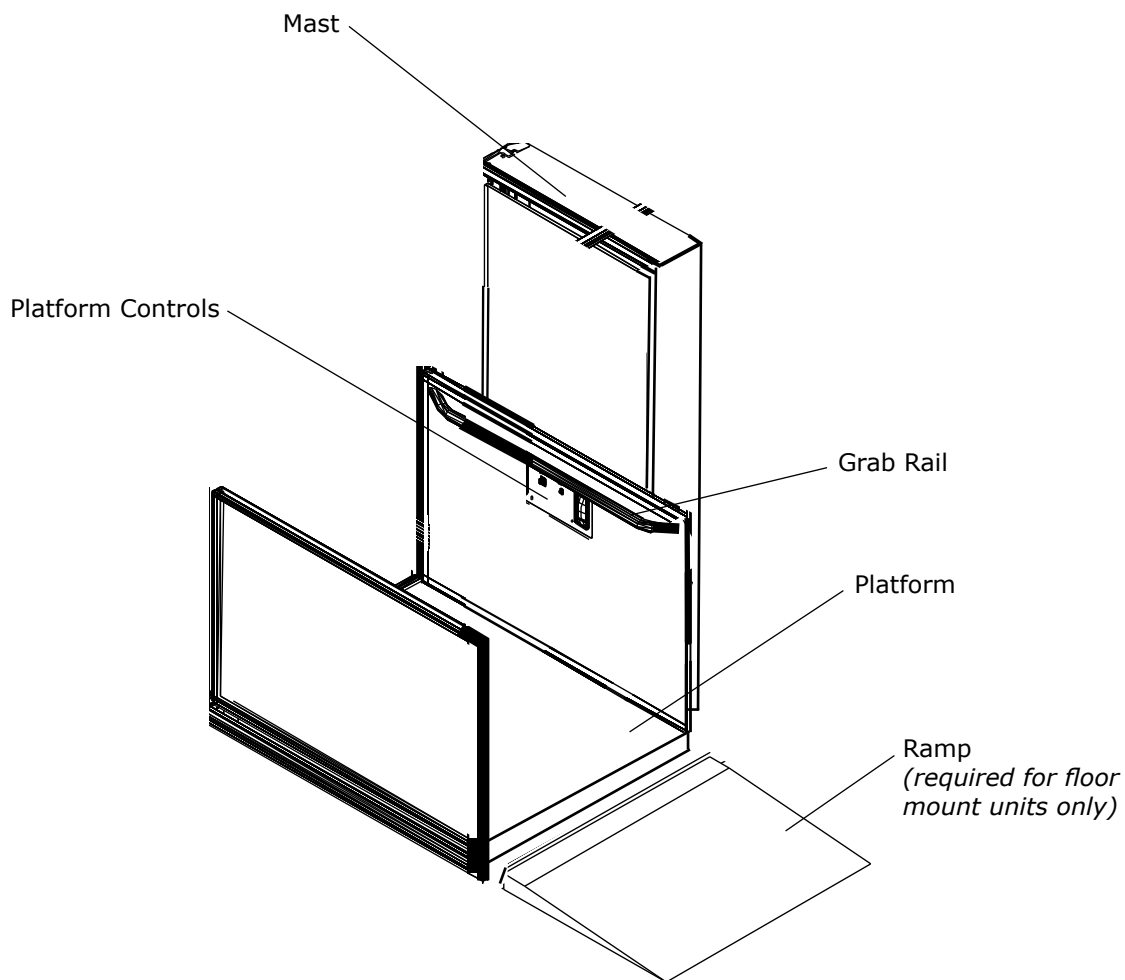

Shaftway Model with Standard Straight-Through Configuration Shown

Lifting Heights and Mast Sizes

The mast size required for a particular site is determined by the vertical travel required between the upper and lower landings. When the site is measured, **the lift height "H" is always defined as the distance from the lower landing (pit or floor bottom) where the lift will sit to the upper landing floor** as shown in

the diagram below. An accurate "H" measurement is crucial for your custom designed lift. Be certain the height you provide is accurate. We strongly recommend using the "as built" dimension.

The width of the mast is 998mm (39 1/4") for all mast heights.

Based on the measured value of "H" the drive mast is selected as follows:

Mast Size	Max. "H" Value	Mast Structure Height	Mast Tieback Height
GVL - 42	1143mm (45")	1737mm (68 3/8")	1643mm (65")
GVL - 60	1600mm (63")	2194mm (86 3/8")	2101mm (83")
GVL - 72	1905mm (75")	2498mm (98 3/8")	2405mm (95")
GVL - 96	2515mm (99")	3108mm (122 3/8")	3015mm (119")
GVL - 120	3124mm (123")	3718mm (146 3/8")	3625mm (143")
GVL - 144	3734mm (147")	4327mm (170 3/8")	4243mm (167")
GVL - 168*	4343mm (171")*	4937mm (194 3/8")*	4844mm (191")

For Shaftway units, a second Tie Back is required on both sides of the mast.

Refer to Loading Diagram and Force Reactions Table on pages 30 & 31.

*Hydraulic drive only and Split Mast standard with this height.

Two stop lift in a pit and floor mount application. An optional three stop unit is also available.

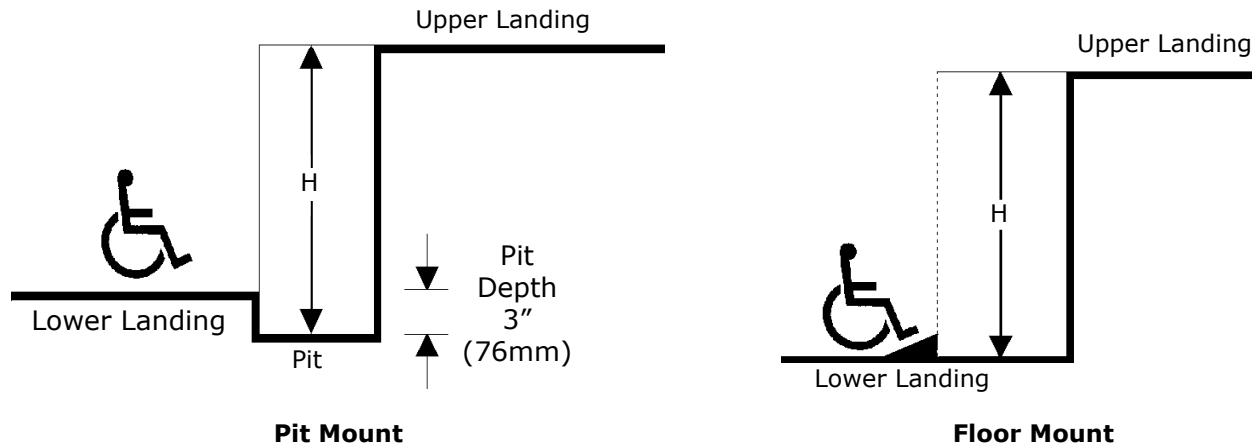

Leadscrew Drive System

Single-phase 2 HP motor attached to a 1" ACME screw, the platform travels at 3 meters (10 ft.) per minute.

Mains Power Requirement:

North America

120 VAC single phase on a dedicated 20 amp circuit.

International

208 - 240 VAC single phase on a dedicated 16 amp circuit.

Electrical Disconnect (optional)

An electrical disconnect can be supplied with the lift for both safety reasons and customer convenience. This disconnect shuts off the mains power and the 24V battery lowering system to the lift. For the Enclosure Model, the disconnect is located on the side of the mast closest to the lower landing door. For the Shaftway Model, the disconnect is located on the outside of the shaftway walls in a location determined by local code requirements.

Manual Lowering Handwheel (Lead Screw Model Only - standard)

The manual lowering handwheel has a black plastic handle and slotted shaft that engages a crosspin on the main drive screw.

Battery Powered Emergency Lowering (Lead Screw Model Only - optional)

The Genesis Leadscrew Model can be supplied with an optional battery-powered emergency lowering system which is automatically activated in the event of a power failure. Using the down directional control, the battery powered emergency lowering system lowers the platform at a speed of approximately 0.3m/min. (1 ft/min.).

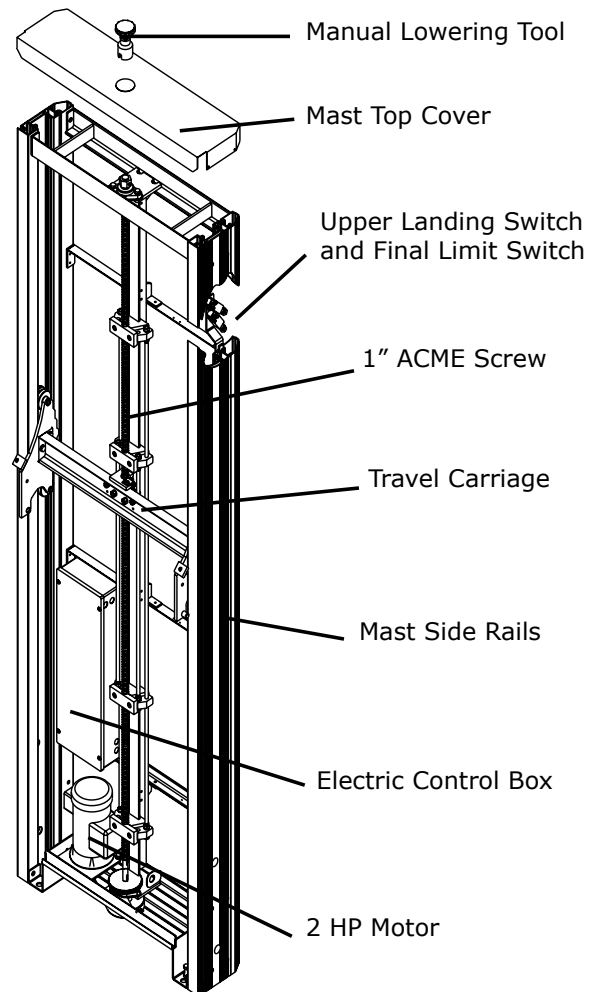

Hydraulic Drive System

Single-phase (2.2 KW), 24VDC hydraulic motor. Continuous mains power and auxiliary power system. The lift connects directly to the building power. The power is reduced to 24 VC to operate the control system and drive the motor. The lift is equipped with an auxiliary power system that enables the lift to operate if mains power is lost. The platform travels between landings at 5.2 meters (17ft.) per minute. ***Required for heavy use lifts or lifts equipped with a Fan and Ventilation System.**

Mains Power Requirement:

North America - 120 VAC single phase on a dedicated 15 amp circuit.

International - 208 - 240 VAC single phase on a dedicated 16 amp circuit.

Full Time Battery Operation

(Hydraulic Drive Only - optional)

For very low use applications and basic units, full time battery operation may be appropriate.

Electrical Disconnect (optional)

An electrical disconnect is supplied with the lift for both safety reasons and customer convenience. This disconnect shuts off the mains power and the 24V battery back-up system to the lift.

The Enclosure Model disconnect is on the side of the mast closest to the lower landing door. The Shaftway Model disconnect is located on the outside of the shaftway wall in a location determined by local code requirements.

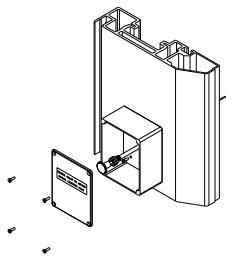

Manual Lowering Valve (shown above)

(Hydraulic Model Only - standard)

The manual emergency lowering device consists of a pull knob mounted in a box on the side of the mast. When used, the platform is gently lowered to the landing.

Split Mast (Hydraulic Drive Only - optional)

For installation sites where it would be difficult to place the drive mast into position as a single piece, the split mast option is available for GVL-120 and GVL-144. GVL-168 Hydraulic Models are supplied standard with a split mast.

Raised Pump and Control Box

(Hydraulic Drive Only - optional)

This option is ideal for locations that are subject to flooding. The pump and electrical controls are re-located higher (exact location depends upon mast size). Available for 96" mast heights and taller.

Remote Drive Cabinet

(Hydraulic Drive Only - optional)

For the ultimate in quiet operation, the drive system can be located up to 3 meters (10 feet) away in a remote drive cabinet.

Mast Heater (Hydraulic Drive Only - optional)

For outside installations where cold temperatures are a concern, a mast heater can be installed to protect hydraulic fluid from freezing.

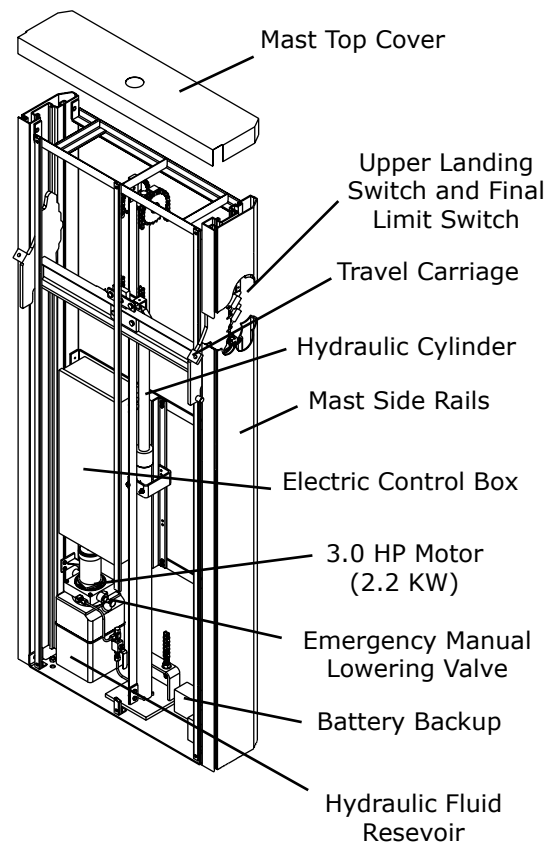

Platforms

The platform is rated for a load of 340 kg. (750 lbs.) and has 1100 mm (43") high side walls. The side wall in front of the mast includes a grab rail and platform controls.

Standard sizes are typically code-compliant for straight through commercial applications. Larger sizes may be required for other on/off configurations or to facilitate ease of use.

The Genesis Shaftway Model has 4 standard platform sizes to meet your requirements:

- Compact
- Standard
- Mid-Size
- Large

Custom sizes are also available.

Exact platform dimensions will vary depending upon the configuration. For platform dimensions, see pages 25-28.

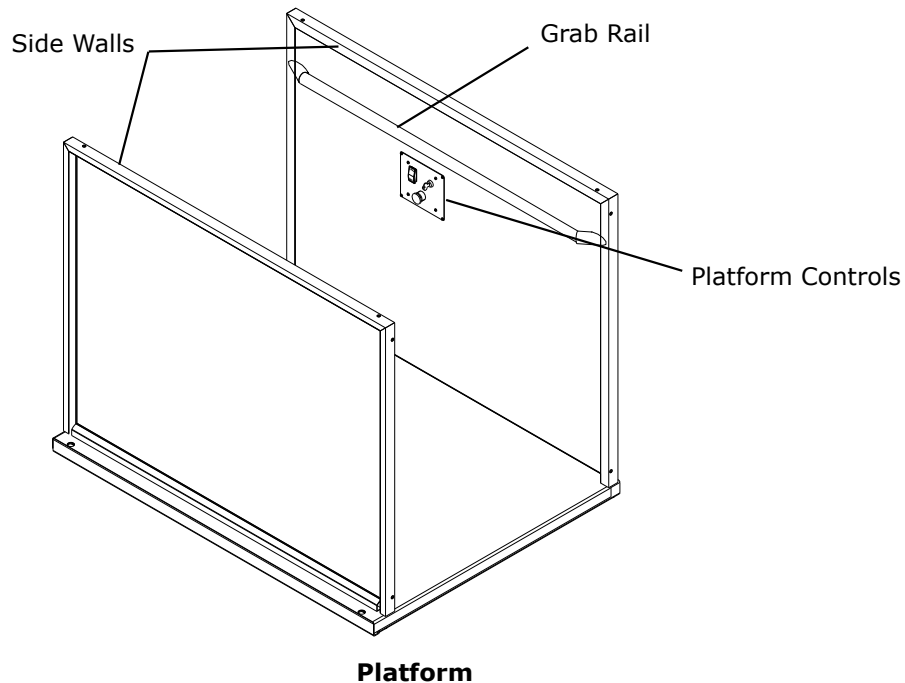

Platform Configurations

Entry/Exit Configurations

The Genesis is available in straight through (180°), 90° (left or right exit) or on/off same side (360°) platform configuration.

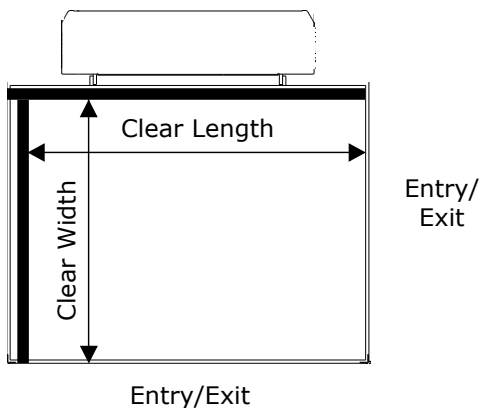

90° Configuration

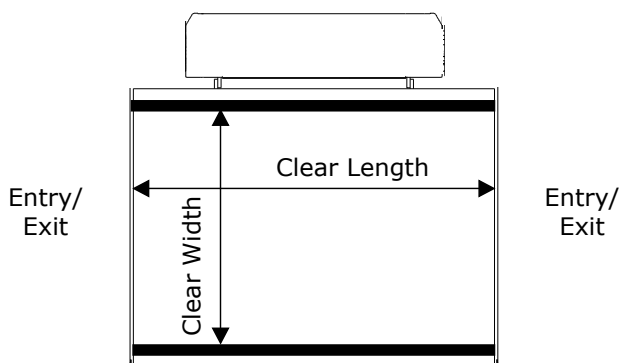

Straight Through (180°) Configuration

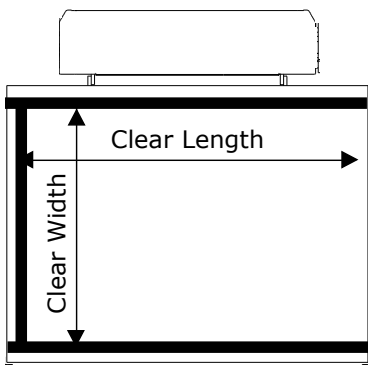

On/Off Same Side (360°) Configuration
(must have a lift height of 2253mm (88 3/4")
or greater)

Operating Controls

Rocker Style Switches (standard)

The Genesis vertical lift comes equipped standard with rugged indoor/outdoor constant pressure switches, rated to IP 67. The platform control panel comes standard with an Illuminated Audible Emergency Stop Switch. All controls can be fitted with an optional AEMA key switch.

Push Button Control Package (optional upgrade)

The Push Button Control Package features illuminated and tactile constant pressure directional control switches. Directional controls also feature braille symbols. Platform courtesy lighting is also included in this upgrade package. It remains illuminated for the duration of platform travel and for 10 seconds after the platform arrives at the landing.

Keyed Call Station and Platform Controls (optional)

Prevents the unauthorized use of the lift. Call stations and platform controls can be set up for keyed operation.

Shaftway Frame Mounted Call Stations: Fire Rated Doors

When a fire rated door is used the call stations are usually mounted in the steel frame of the door, similar to the Garaventa style door call stations. Wall mount call stations are an available option.

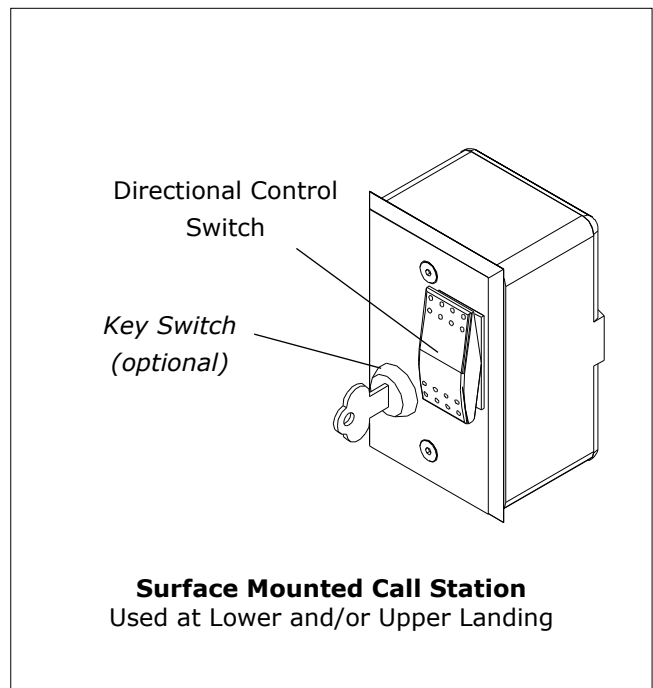
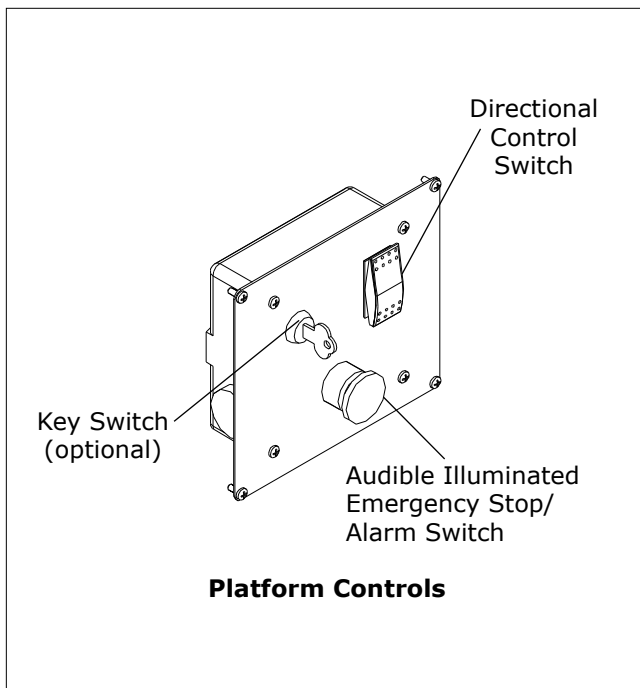
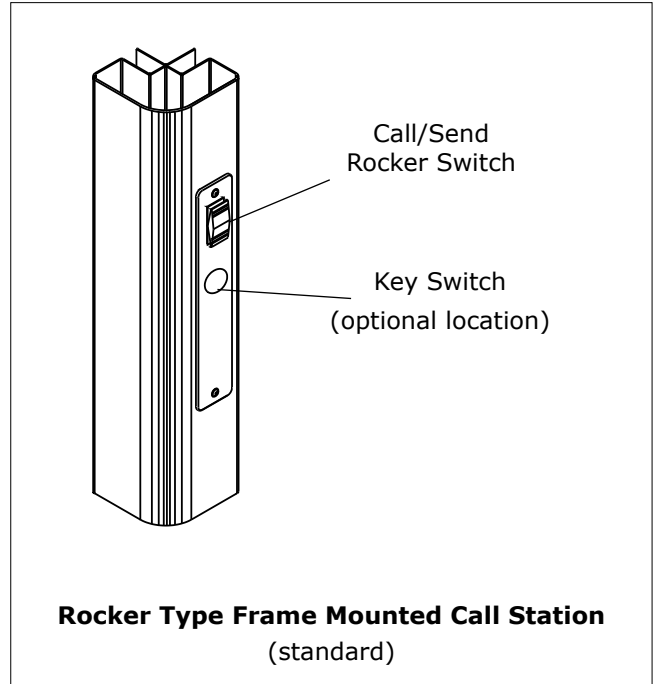

Operating Controls (Continued)

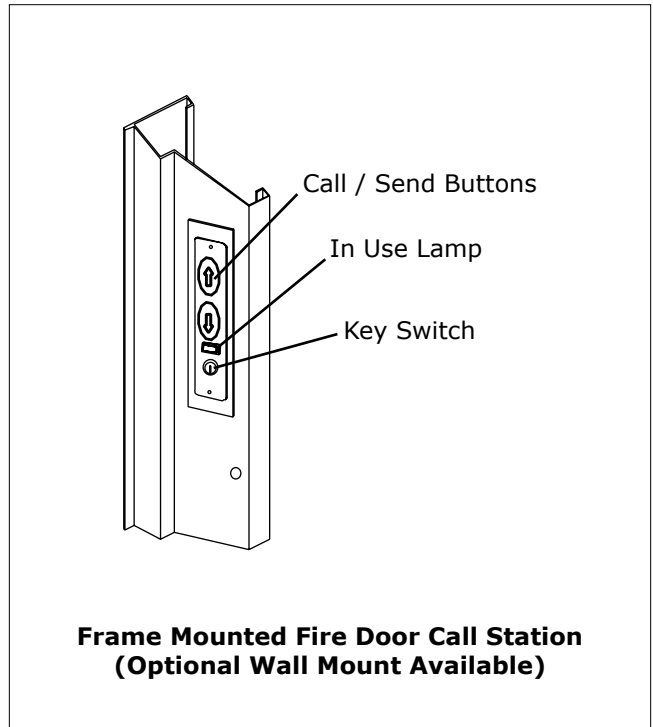
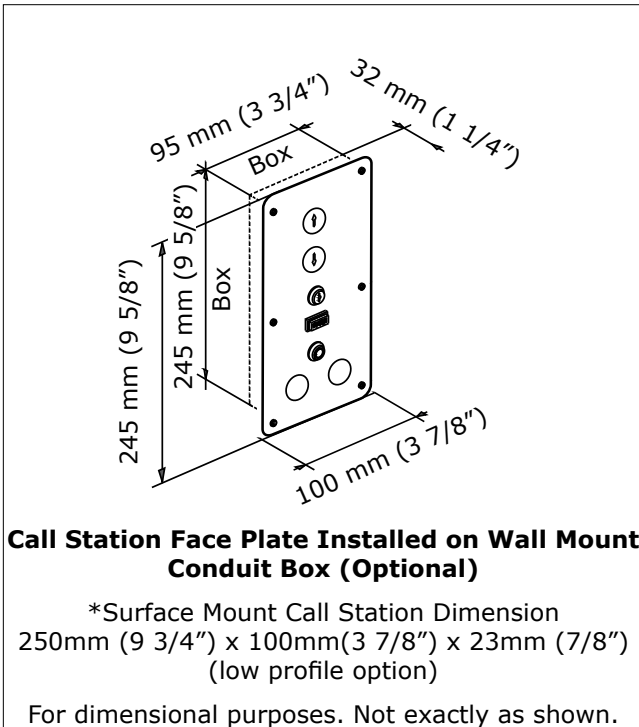
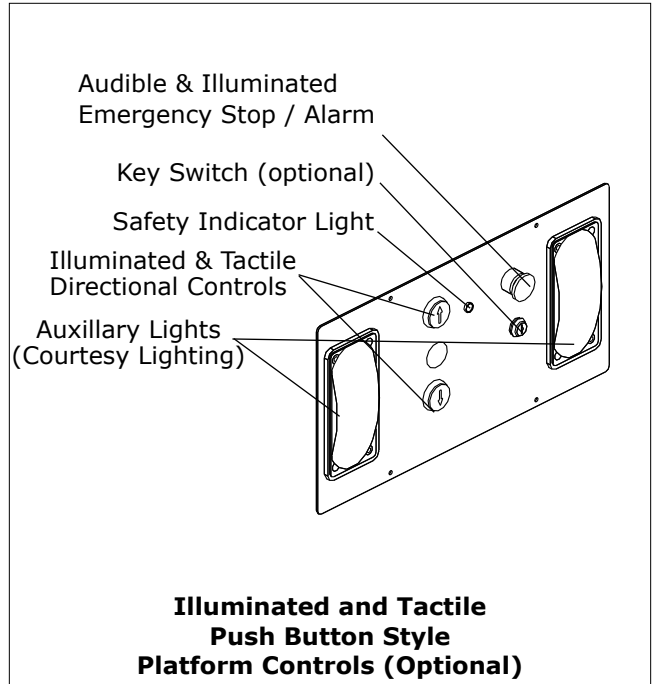
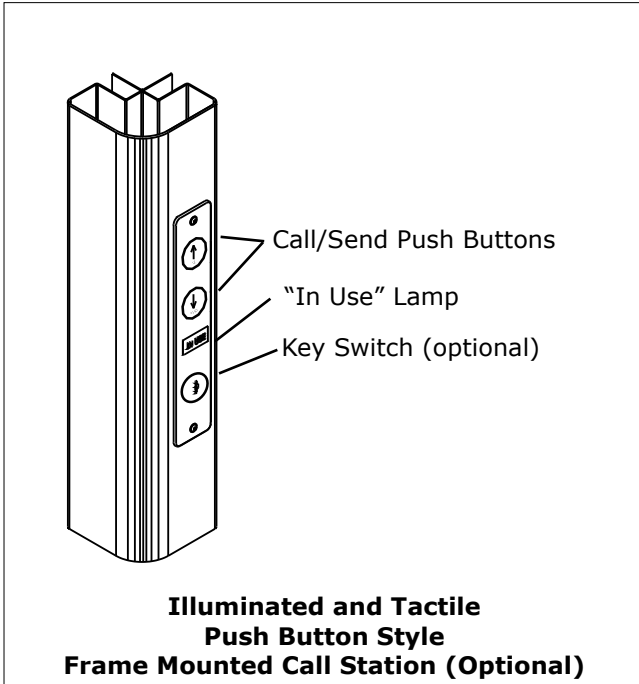

Optional Features

Autodial Telephone

In locations where the lift cannot be easily monitored and as required by code in certain jurisdictions, an autodial telephone can be installed on the platform. The Autodial telephone allows the lift user to call for help with the push of a button, using pre-programmed telephone numbers.

Garaventa PDO - Power Door Operator

The Garaventa Power Door Operator (PDO) enables automatic door opening and closing. It features a clutch to release it in the event of encountering an obstruction or being held open. It is suitable for use on Garaventa style doors and gates with extruded aluminum frames.

Arrival Gong and Digital Floor Display

The platform mounted arrival Gong and Digital Floor Display provide audio and visual platform location information.

Ramps (optional)

A ramp is used when a pit is not provided. The ramps are available in slopes of 1:10 and 1:12. Both slopes are available in widths of 1069mm (42"), 1225mm (48 1/4") or 1375mm (54 1/8"). It is recommended that you use a Power Door Operator and a wall mount call station at landings where a ramp is used. Contact your local authorized Garaventa Lift representative to confirm the local code requirements associated with using a ramp.

Mast Side Wall Panel Kits (optional)

Mast side wall panel kits are available to finish the open space on either side of the mast.

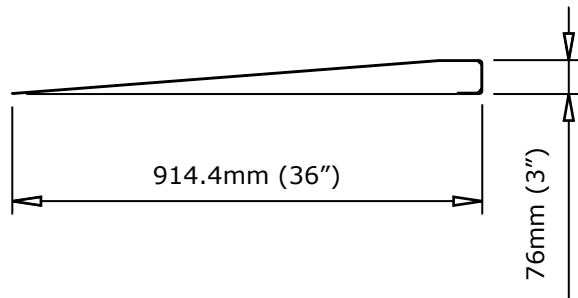

Lower Landing Fixed Ramp
(1:12 slope shown, 1:10 also available)

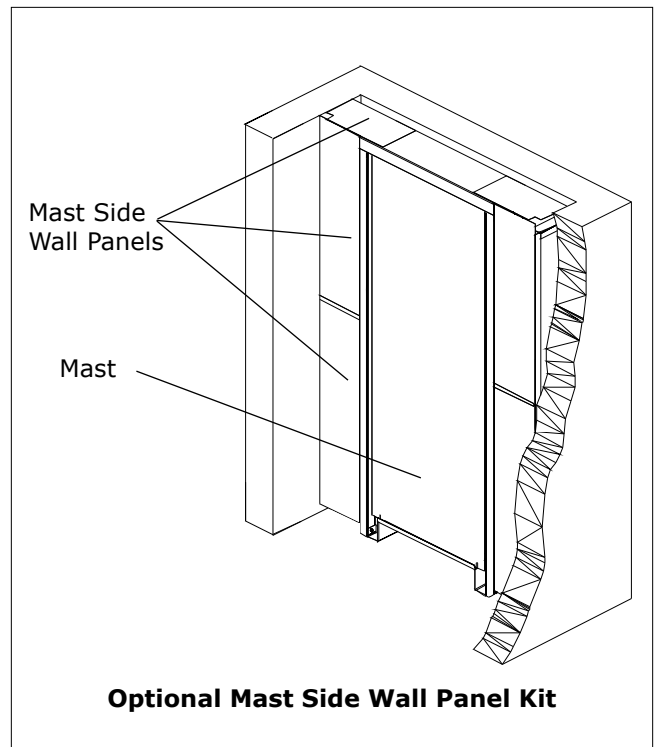

Optional Mast Side Wall Panel Kit

Garaventa Style Doors & Gates

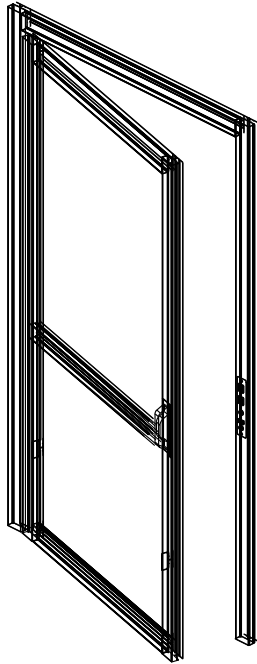

The standard Genesis doors and gates are referred to as "Garaventa style doors and/or gates". These non-fire rated doors and gates are prehung in a Champagne colored anodized aluminum extrusion frame. The doors and gates are constructed of matching aluminum extrusions with a powder coated 16 gauge galvanized steel kickplate and an upper panel (powder coated 16 gauge galvanized steel, bronze or clear Plexiglas, or laminated glass).

Garaventa doors are equipped with an offset "D" handle. Custom finishes are also available as an option, please refer to page 4. This non-fire rated door and gate are an attractive alternative to the industrial looking fire rated door.

The door height is 2032mm (80") and the gate height is 1070mm (42 1/8") and are both available in 3 widths:

- 905mm (35 5/8")
- 1046mm (41 1/8")
- 1109mm (43 5/8") (for wide side 90° configurations)

The fire rated door and frame is completely prehung and is constructed of 16 gauge steel. The door is supplied with a vision panel and a delayed action door closer. The door has a 1 1/2 hour 'B' label fire rating with an integrated interlock system. This door comes standard with a frame mounted 2-button keyed call station.

Fire Rated Doors & Frames

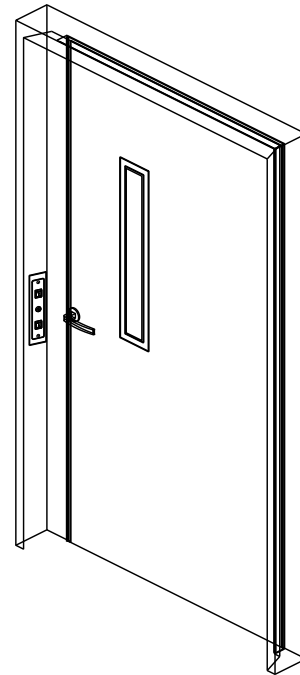

The fire rated door and frame is available in both a nominal 36" (906mm / 35 5/8") and nominal 42" (1059mm / 41 5/8") clear door widths. See the Door Layouts and Clearances section on pages 21-24 for further door and door swing dimensions.

Door Locks

Powerlock 2000 (CSA Certified)

The Powerlock 2000 is standard for Genesis Shaftway model lifts that are equipped with Garaventa style doors and/or gates. The Powerlock 2000 is a 24 VDC interlock that is monitored by the safety circuit to ensure that the Garaventa style door/gate is properly secured when the platform is away from the landing.

Locks by Others

Garaventa lifts can be configured to accept interlocks or strikes by others, typically found in fire doors. Consult your local Garaventa Lift representative for more information.

Power Door Operators (PDOs) by Others

Garaventa lifts can be configured to accept by PDOs by others. Consult your local Garaventa Lift representative for more information.

Garaventa Style Door Dimensions - Straight Through (180°) Entry/Exit

Door	Door Width	R/O* Width	R/O* Height	Door Swing	Door Projection
36"	905mm (35 5/8")	1098mm (43 1/4")	2140mm (84 1/4")	926mm (36 1/2")	982mm (38 5/8")
42"	1046mm (41 1/8")	1240mm (48 7/8")	2140mm (84 1/4")	1067mm (42")	1123mm (44 1/4")
44"	1109mm (43 5/8")	1302mm (51 1/4")	2140mm (84 1/4")	1104mm (43 1/2")	1162mm (45 3/4")

R/O* is Rough Opening

Platform Size	Platform ϕ Dimension
Compact	771mm (30 3/8")
Standard	809mm (31 7/8")
Mid-Size	809mm (31 7/8")
Large	885mm (34 7/8")

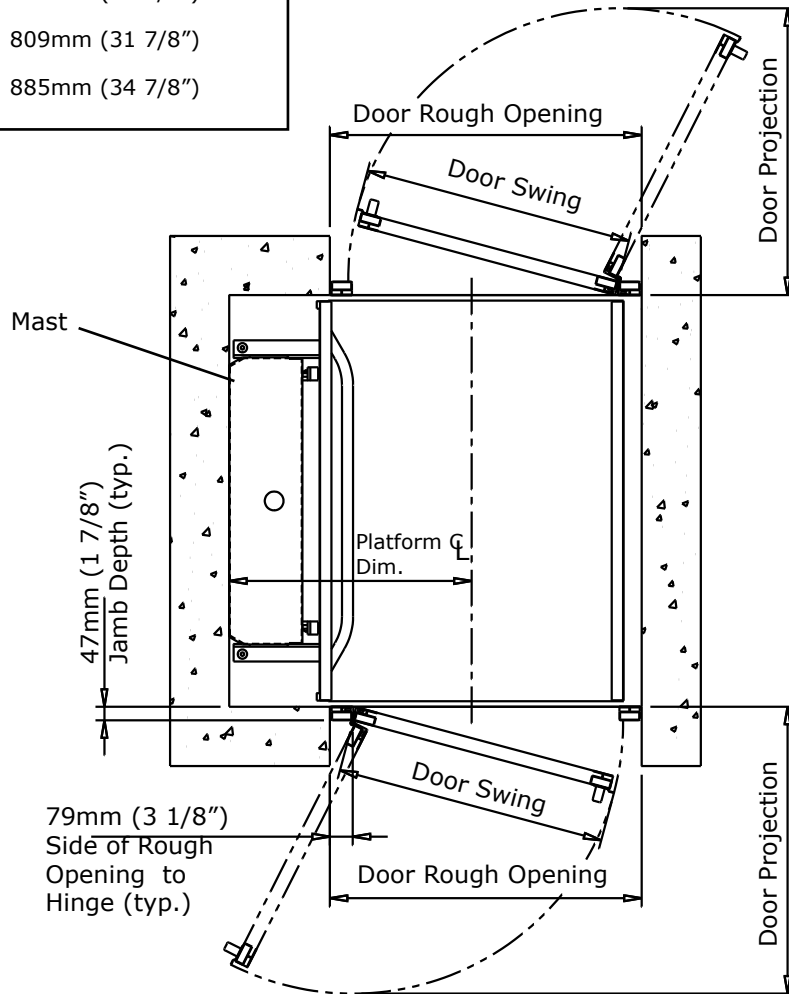

Dimensions are provided for reference only. Submittal drawing dimensions should be used for site preparation and construction.

Garaventa Style Door Dimensions - 90° Entry/Exit

Door	Door Width	R/O* Width	R/O* Height	Door Swing	Door Projection
36"	905mm (35 5/8")	1098mm (43 1/4")	2140mm (84 1/4")	926mm (36 1/2")	982mm (38 5/8")
42"	1046mm (41 1/8")	1240mm (48 7/8")	2140mm (84 1/4")	1067mm (42")	1123mm (44 1/4")
44"	1109mm (43 5/8")	1302mm (51 1/4")	2140mm (84 1/4")	1104mm (43 5/8")	1162mm (45 3/4")

R/O* is Rough Opening

Platform Size	Platform \varnothing Dimension
Compact	783mm (30 7/8")
Standard	822mm (32 3/8")
Mid-Size	822mm (32 3/8")
Large	898mm (35 3/8")

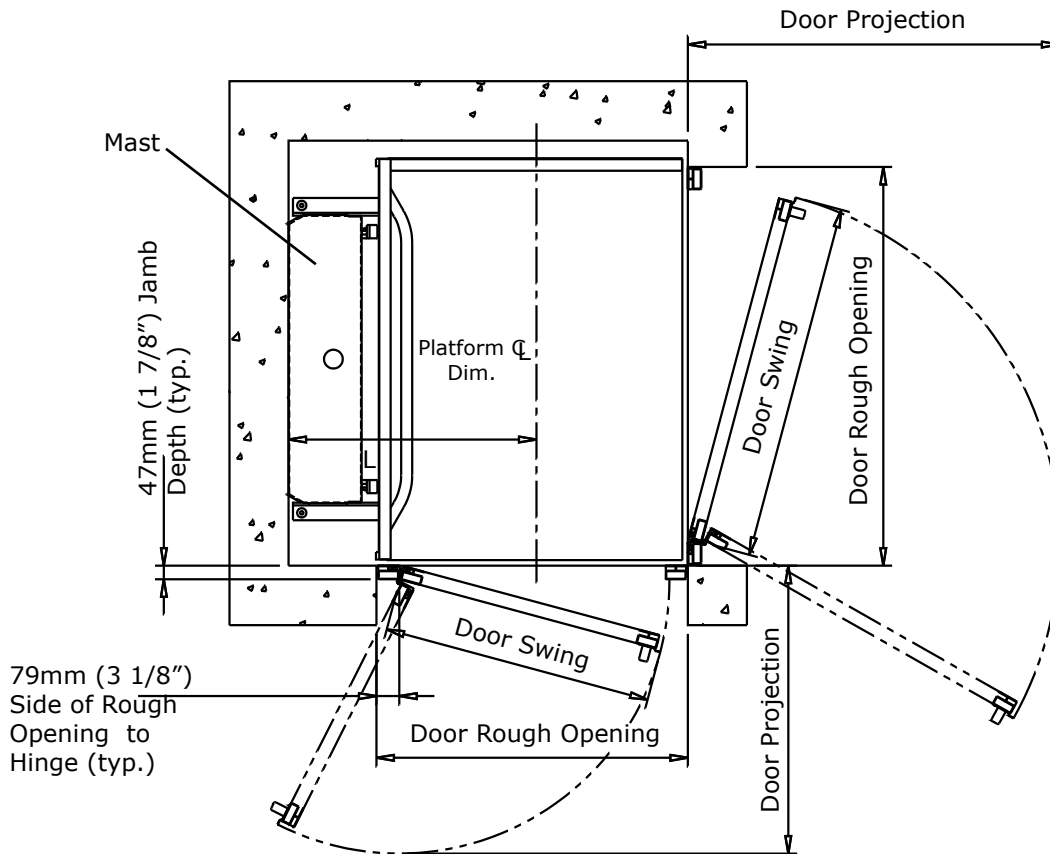

Dimensions are provided for reference only. Submittal drawing dimensions should be used for site preparation and construction.

Garaventa Style Door Dimensions - On/Off Same Side (Entry/Exit Adjacent to Mast)

Door	Door Width	R/O* Width	R/O* Height	Door Swing	Door Projection
36"	905mm (35 5/8")	1098mm (43 1/4")	2140mm (84 1/4")	926mm (36 1/2")	982mm (38 5/8")
42"	1046mm (41 1/8")	1240mm (48 7/8")	2140mm (84 1/4")	1067mm (42")	1123mm (44 1/4")
44"	1109mm (43 5/8")	1302mm (51 1/4")	2140mm (84 1/4")	1104mm (43 5/8")	1162mm (45 3/4")

R/O* is Rough Opening

Platform Size	Platform ϕ Dimension
Compact	771mm (30 3/8")
Standard	809mm (31 7/8")
Mid-Size	809mm (31 7/8")
Large	885mm (34 7/8")

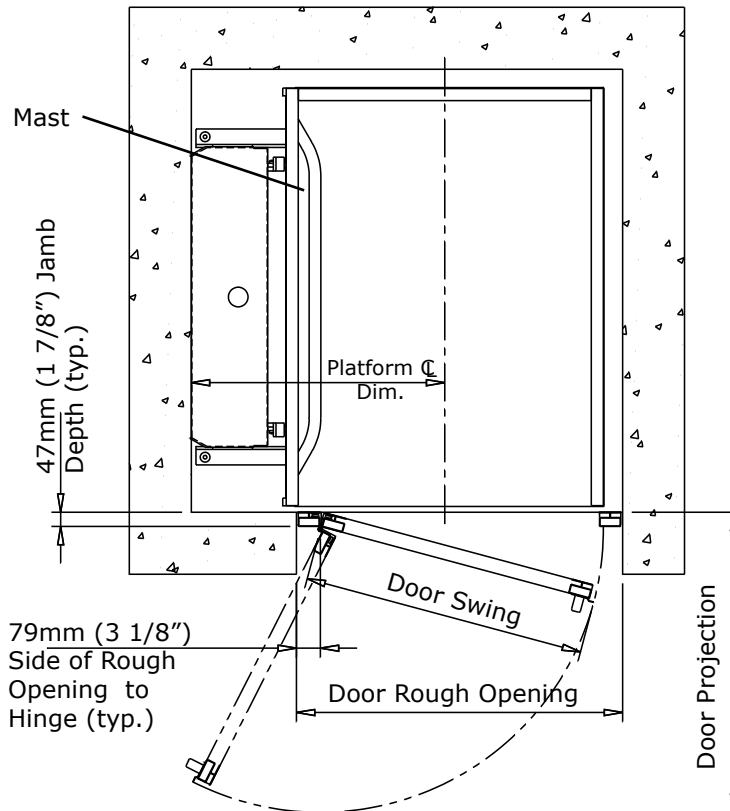

Dimensions are provided for reference only. Submittal drawing dimensions should be used for site preparation and construction.

Garaventa Style Door Dimensions - On/Off Same Side (Entry/Exit Opposite to Mast)

Door	Door Width	R/O* Width	R/O* Height	Door Swing	Door Projection
36"	905mm (35 5/8")	1098mm (43 1/4")	2140mm (84 1/4")	926mm (36 1/2")	982mm (38 5/8")
42"	1046mm (41 1/8")	1240mm (48 7/8")	2140mm (84 1/4")	1067mm (42")	1123mm (44 1/4")
44"	1109mm (43 5/8")	1302mm (51 1/4")	2140mm (84 1/4")	1104mm (43 5/8")	1162mm (45 3/4")

R/O* is Rough Opening

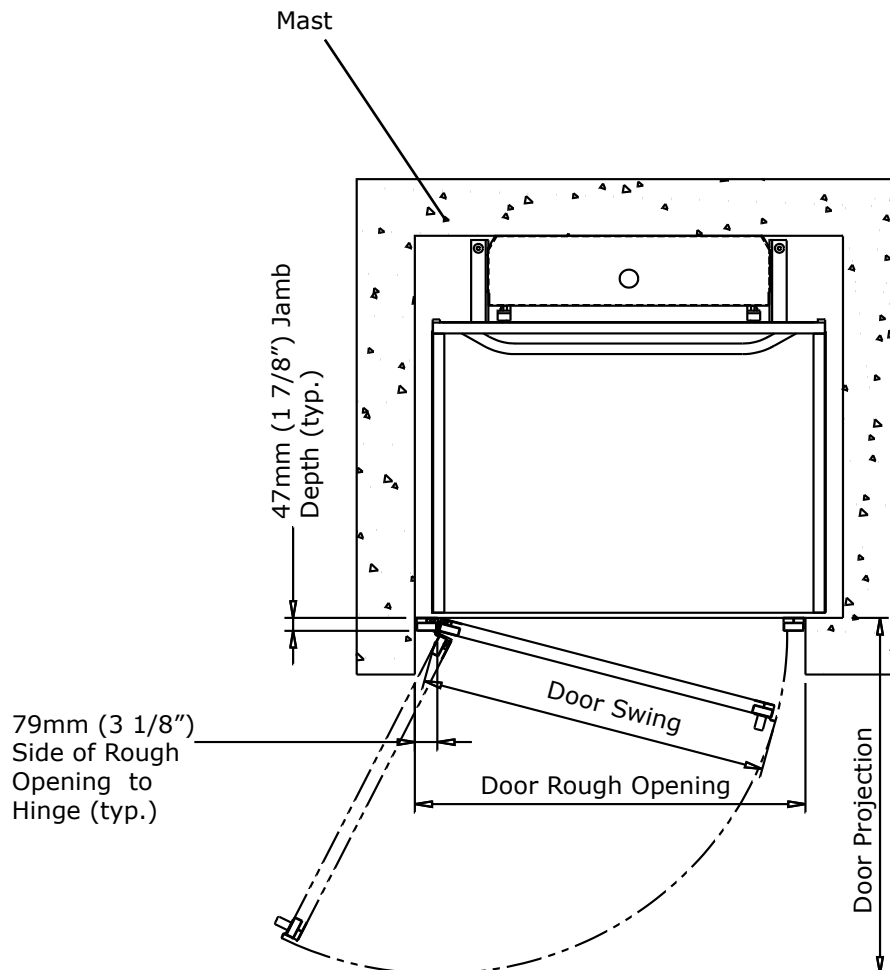

Dimensions are provided for reference only. Submittal drawing dimensions should be used for site preparation and construction.

Fire Rated Door Dimensions - Straight Through Entry/Exit

Door	Door Width	R/O* Width	R/O* Height	Door Swing	Door Projection
36"	908mm (35 3/4")	1131mm (44 1/2")	2140mm (84 1/4")	933mm (36 3/4")	985mm (38 7/8")
42"	1060mm (41 3/4")	1283mm (50 1/2")	2140mm (84 1/4")	1085mm (42 3/4")	1138mm (44 7/8")

Add 102mm (4") to R/O height when using a Falcon Power Door Operator

R/O* Rough Opening

Platform Size	Platform \varnothing Dimension
Compact	771mm (30 3/8")
Standard	809mm (31 7/8")
Mid-Size	809mm (31 7/8")
Large	885mm (34 7/8")

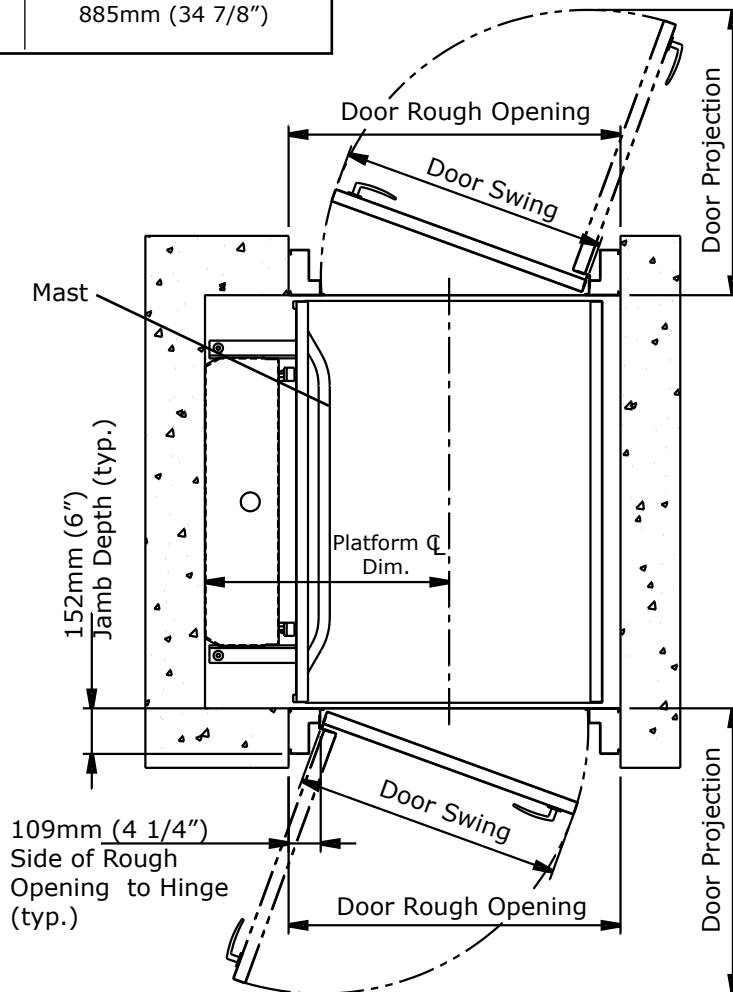

Dimensions are provided for reference only. Submittal drawing dimensions should be used for site preparation and construction.

Fire Rated Door Dimensions - 90° Entry/Exit

Door	Door Width	R/O* Width	R/O* Height	Door Swing	Door Projection
36"	908mm (35 3/4")	1131mm (44 1/2")	2140mm (84 1/4")	933mm (36 3/4")	985mm (38 7/8")
42"	1060mm (41 3/4")	1283mm (50 1/2")	2140mm (84 1/4")	1085mm (42 3/4")	1138mm (44 7/8")

Add 102mm (4") to R/O height when using a Falcon Power Door Operator

R/O* Rough Opening

Platform Size	Platform \varnothing Dimension
Compact	783mm (30 7/8")
Standard	822mm (32 3/8")
Mid-Size	822mm (32 3/8")
Large	898mm (35 7/8")

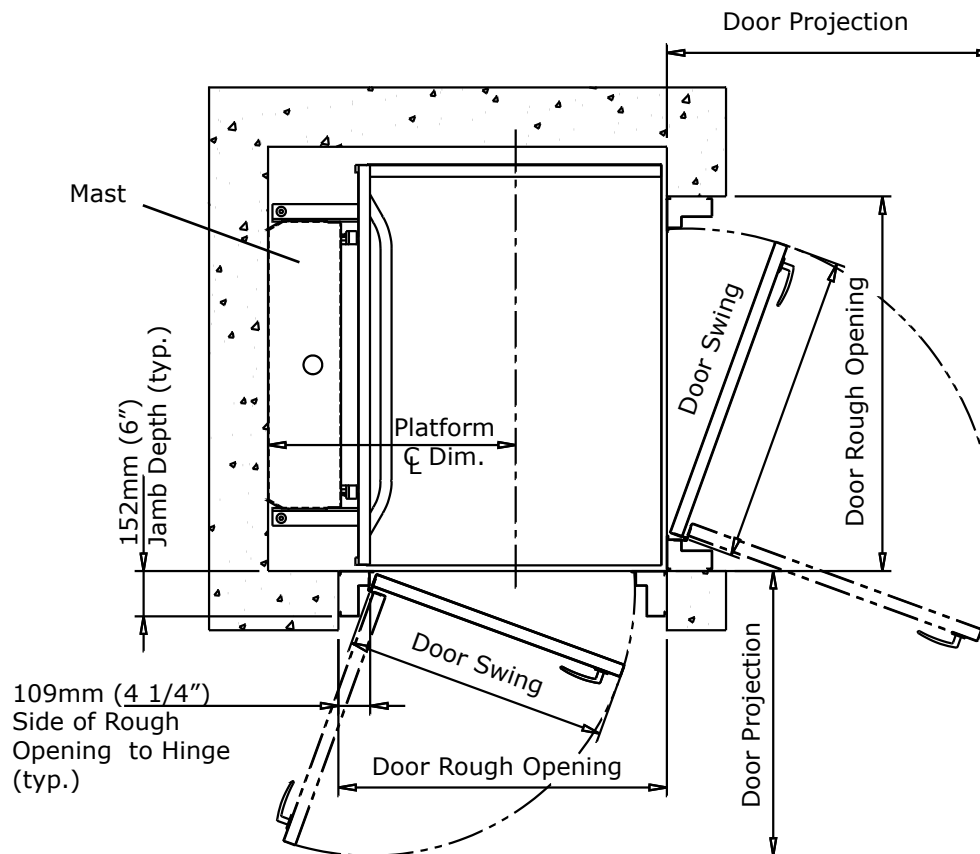

Dimensions are provided for reference only. Submittal drawing dimensions should be used for site preparation and construction.

Fire Rated Door Dimensions - On/Off Same Side (Entry/Exit Adjacent to Mast)

Door	Door Width	R/O* Width	R/O* Height	Door Swing	Door Projection
36"	908mm (35 3/4")	1131mm (44 1/2")	2140mm (84 1/4")	933mm (36 3/4")	985mm (38 7/8")
42"	1060mm (41 3/4")	1283mm (50 1/2")	2140mm (84 1/4")	1085mm (42 3/4")	1138mm (44 7/8")

Add 102mm (4") to R/O height when using a Falcon Power Door Operator

R/O* Rough Opening

Platform Size	Platform \varnothing Dimension
Compact	771mm (30 3/8")
Standard	809mm (31 7/8")
Mid-Size	809mm (31 7/8")
Large	885mm (34 7/8")

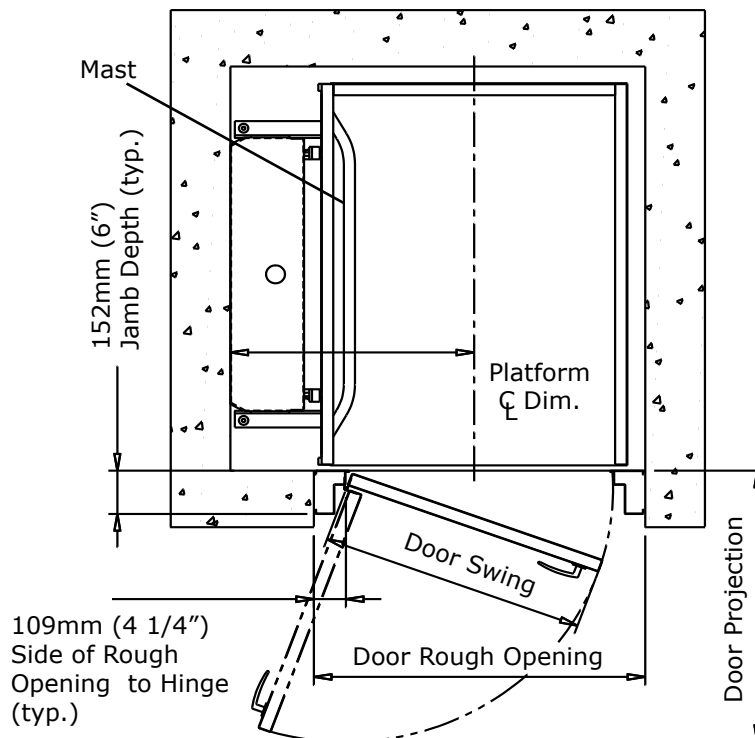

Dimensions are provided for reference only. Submittal drawing dimensions should be used for site preparation and construction.

Fire Rated Door Dimensions - On/Off Same Side (Entry/Exit Opposite to Mast)

Door	Door Width	R/O* Width	R/O* Height	Door Swing	Door Projection
36"	908mm (35 3/4")	1131mm (44 1/2")	2140mm (84 1/4")	933mm (36 3/4")	985mm (38 7/8")
42"	1060mm (41 3/4")	1283mm (50 1/2")	2140mm (84 1/4")	1085mm (42 3/4")	1138mm (44 7/8")

Add 102mm (4") to R/O height when using a Falcon Power Door Operator

R/O* Rough Opening

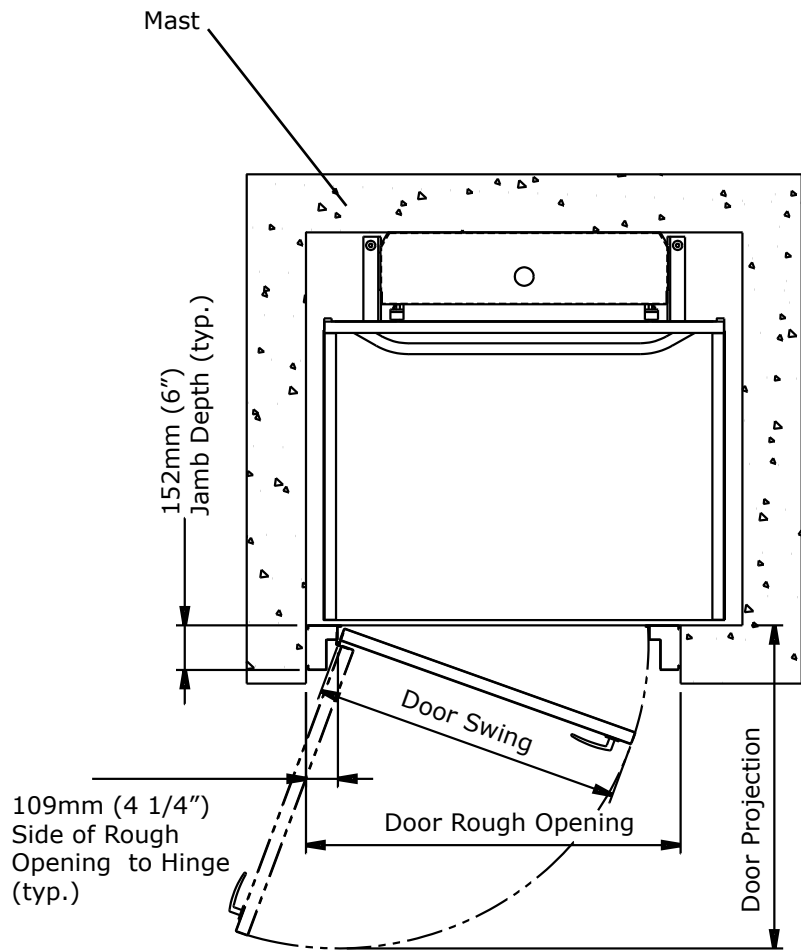

Dimensions are provided for reference only. Submittal drawing dimensions should be used for site preparation and construction.

Shaftway/Pit and Platform Clear Dimensions - Straight Through (180°) Entry/Exit

Platform Size	Shaftway/Pit Width	Shaftway/Pit Length	Clear Width	Clear Length	Net Usable Area
Compact	1317mm (51 7/8")	1295mm (51")	914mm (36")	1257mm (49 1/2")	1.15sq.m. (12.4 sq. ft.)
Standard	1394mm (54 7/8")	1407mm (55 3/8")	992mm (39")	1370mm (53 7/8")	1.36sq.m. (14.61 sq. ft.)
Mid-Size	1394mm (54 7/8")	1558mm (61 3/8")	992mm (39")	1520mm (59 7/8")	1.57sq.m. (16.23 sq. ft.)
Large	1546mm (60 7/8")	1558mm (61 3/8")	1146mm (45")	1520mm (59 7/8")	1.74sq.m. (18.0 sq. ft.)

- Add 38mm (1 1/2") to pit width if a mast tie-back rail is used.
- 63 1/2mm (2 1/2") running clearance dimension is included on non entry exit sides
- 19mm (3/4") running clearance dimension is included on entry / exit sides
- Shaftway units require (4) mast tie back locations (2 per side).

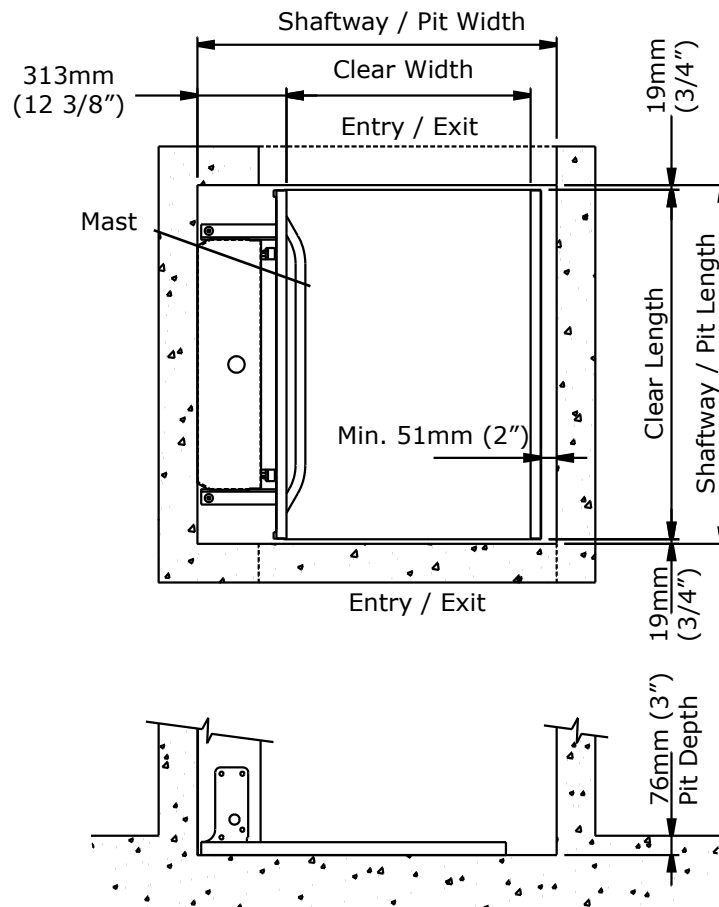

Straight Through (180°) Entry/Exit Shaftway/Pit and Platform Clear Dimensions

Dimensions are provided for reference only. Submittal drawing dimensions should be used for site preparation and construction.

Shaftway/Pit and Platform Clear Dimensions - 90° Entry/Exit

Platform Size	Shaftway/Pit Width	Shaftway/Pit Length	Clear Width	Clear Length	Net Usable Area
Compact	1272mm (50 1/8")	1316mm (51 7/8")	940mm (37")	1208mm (47 1/2")	1.14sq.m. (12.2 sq. ft.)
Standard	1350mm (53 1/8")	1428mm (56 1/4")	1017mm (40")	1320mm (52")	1.34sq.m. (14.45 sq. ft.)
Mid-Size	1350mm (53 1/8")	1579mm (62 1/8")	1017mm (40")	1471mm (57 7/8")	1.50sq.m. (16.11 sq. ft.)
Large	1502mm (59 1/8")	1579mm (62 1/8")	1169mm (46")	1471mm (57 7/8")	1.72sq.m. (18.0 sq. ft.)

- Add 38mm (1 1/2") to pit width if a mast tie-back rail is used.
- 63 1/2mm (2 1/2") running clearance dimension is included on non entry exit sides
- 19mm (3/4") running clearance dimension is included on entry / exit sides
- Shaftway units require (4) mast tie back locations (2 per side).

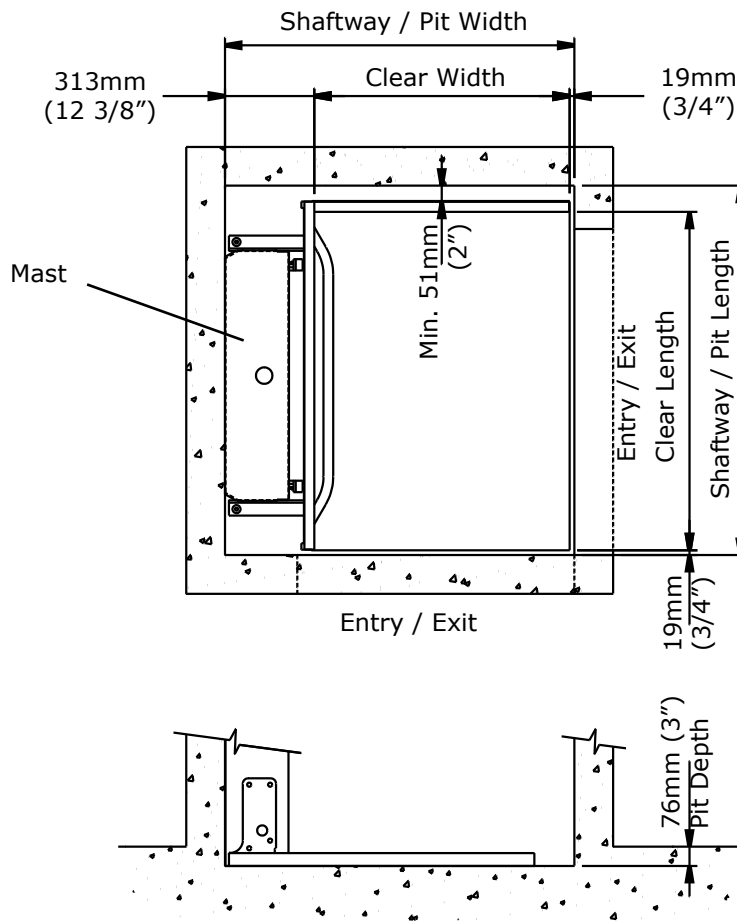

90° Entry/Exit Shaftway/Pit and Platform Clear Dimensions

Dimensions are provided for reference only. Submittal drawing dimensions should be used for site preparation and construction.

Shaftway/Pit and Platform Clear Dimensions - On/Off Same Side (360°) Entry/Exit Adjacent to Mast

Platform Size	Shaftway/Pit Width	Shaftway/Pit Length	Clear Width	Clear Length	Net Usable Area
Compact	1317mm (51 7/8")	1316mm (51 7/8")	914mm (36")	1209mm (47 1/2")	1.10sq.m. (11.89 sq. ft.)
Standard	1394mm (54 7/8")	1428mm (56 1/4")	992mm (39")	1320mm (52")	1.31sq.m. (14.09 sq. ft.)
Mid-Size	1394mm (54 7/8")	1579mm (62 1/8")	992mm (39")	1471mm (57 7/8")	1.46sq.m. (15.71 sq. ft.)
Large	1546mm (60 7/8")	1579mm (62 1/8")	1144mm (45")	1471mm (57 7/8")	1.68sq.m. (18.0 sq. ft.)

- Add 38mm (1 1/2") to pit width if a mast tie-back rail is used.
- 63 1/2mm (2 1/2") running clearance dimension is included on non entry exit sides
- 19mm (3/4") running clearance dimension is included on entry / exit sides
- Shaftway units require (4) mast tie back locations (2 per side).

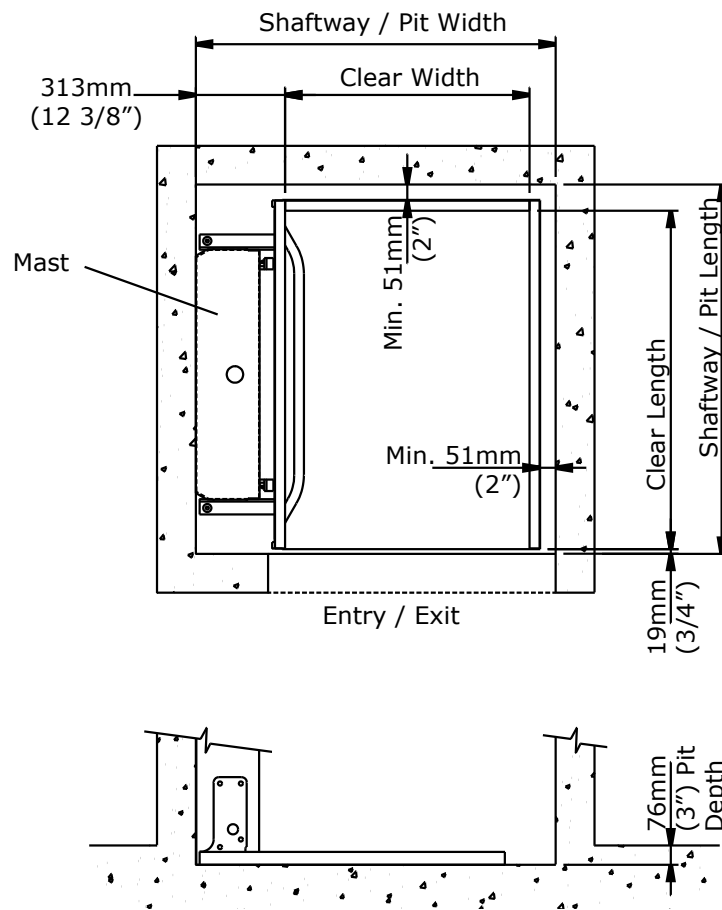

On/Off Same Side (360°) Entry/Exit Adjacent to Mast Shaftway/Pit & Platform Dimensions

Dimensions are provided for reference only. Submittal drawing dimensions should be used for site preparation and construction.

Shaftway/Pit and Platform Clear Dimensions - On/Off Same Side (360°) Entry/Exit Opposite Mast

Platform Size	Shaftway/Pit Width	Shaftway/Pit Length	Clear Width	Clear Length	Net Usable Area
Compact	1272mm (50 1/8")	1337mm (52 7/8")	940mm (37")	1159mm (45 5/8")	1.09sq.m. (11.72 sq. ft.)
Standard	1350mm (53 1/8")	1448mm (57")	1017mm (40")	1271mm (50")	1.29sq.m. (13.91 sq. ft.)
Mid-Size	1350mm (53 1/8")	1600mm (63")	1017mm (40")	1422mm (56")	1.45sq.m. (15.57 sq. ft.)
Large	1502mm (59 1/8")	1600mm (63")	1169mm (46")	1422mm (56")	1.66sq.m. (17.90 sq. ft.)

- Add 38mm (1 1/2") to pit width if a mast tie-back rail is used.
- 63 1/2mm (2 1/2") running clearance dimension is included on non entry exit sides
- 19mm (3/4") running clearance dimension is included on entry / exit sides
- Shaftway units require (4) mast tie back locations (2 per side).

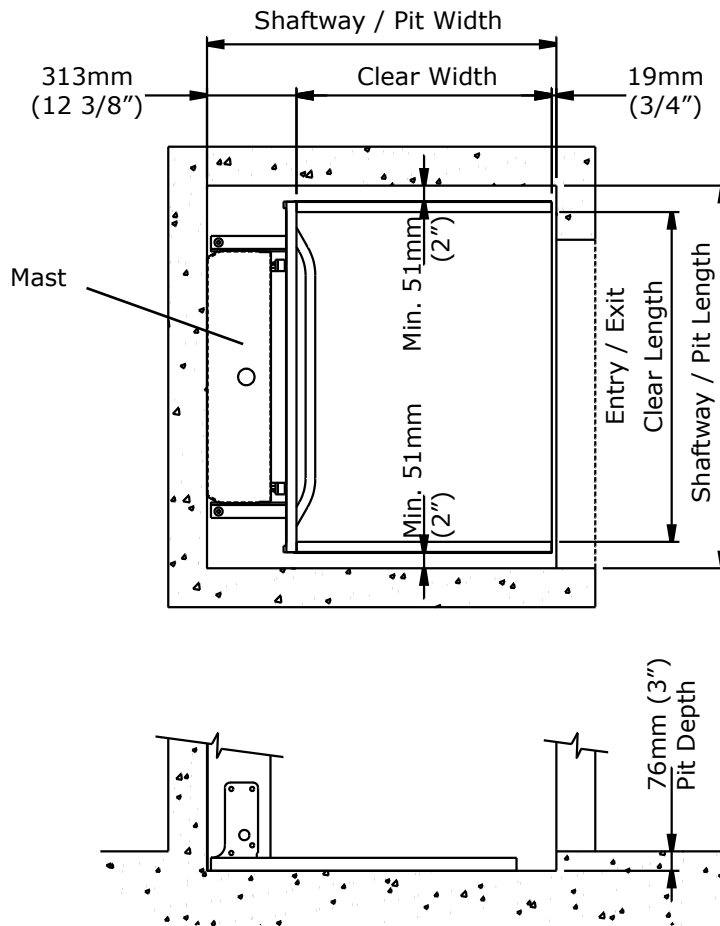

On / Off Same Side (360°) Entry/Exit Opposite Mast Shaftway/Pit and Platform Dimensions

Dimensions are provided for reference only. Submittal drawing dimensions should be used for site preparation and construction.

Base Attachment

The Genesis Shaftway mast is fastened to the floor/pit at the lower landing. It is recommended that the floor is a level concrete surface rated for 3500 PSI with a minimum thickness of 102mm (4"). If the floor surface does not meet these specifications, it must be able to withstand the loads shown on the loading diagram.

Mast Attachment

The Genesis is supplied with adjustable tie back brackets. These brackets are fastened to the mast and installed into a load bearing support wall. This helps to stabilize the mast. Refer to the loading diagram for the loads that must be supported by the wall.

An optional Tie Back Rail Kit can be used to spread the load when attaching to a timber stud wall.

CAUTION: Using a Tie Back Rail Kit will increase the required shaftway width by 38 mm (1.5").

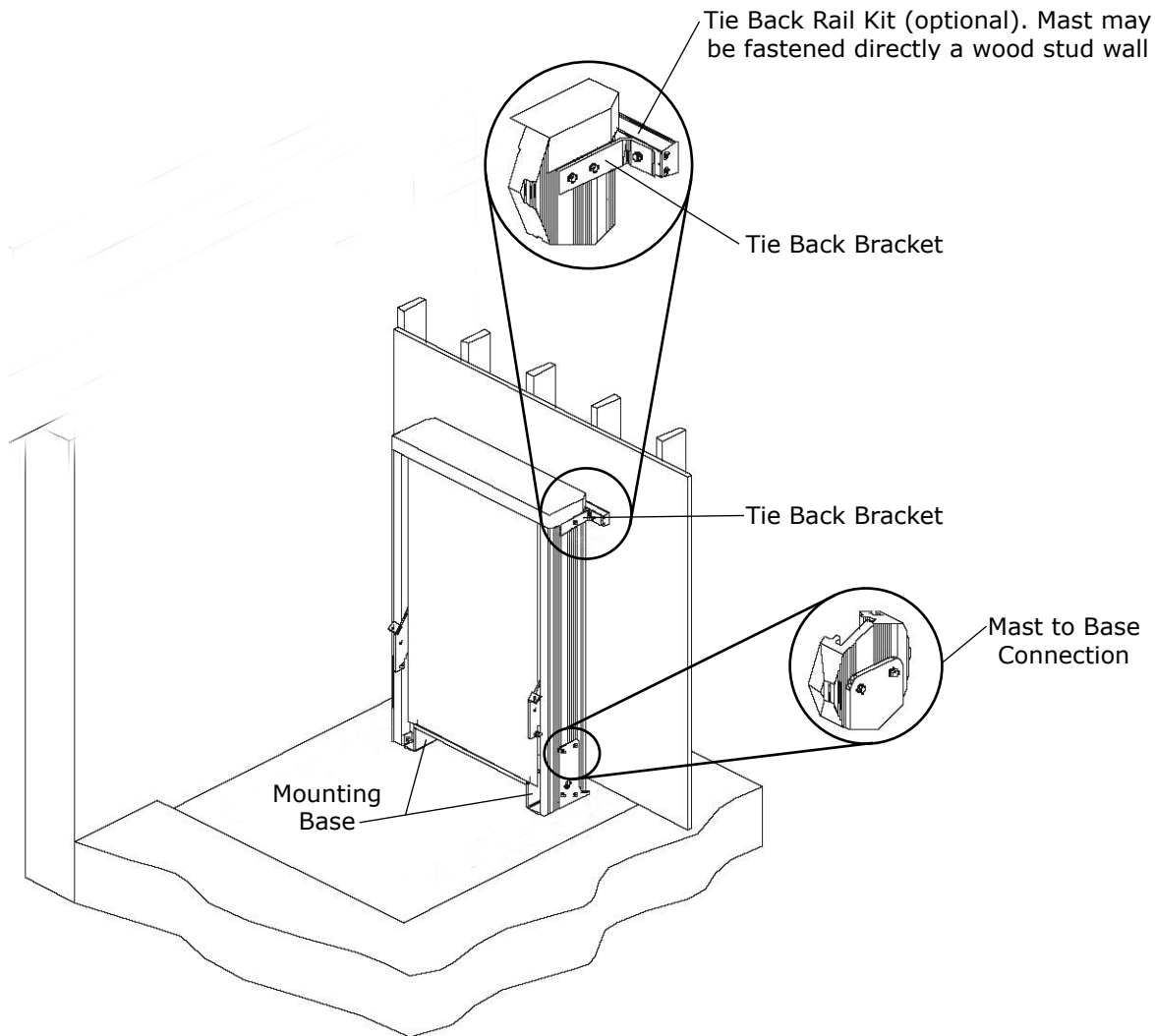

Attachment Details

Lead Screw Drive System: Technical Reference

Shaftway Platform Sizes:

- Compact
- Standard
- Mid-size
- Large

Exact clear platform dimensions are listed on pages 25-28.

Rated Load:

340 kg (750 lbs), with a safety factor of 5

Drive System:

Mains Power:

120 VAC single phase on a dedicated 20 amp circuit. Outside N.A. 208-240 VAC single phase on a dedicated 16 amp circuit.

Drive Type: ACME screw (1" diameter)

Motor: 2 HP, AC Motor. Variable frequency control for smooth start and stop.

Speed:

3 meters (10 ft) per minute at full load

Operating Controls:

Keyed Controls: Keyswitch on call stations and platform controls (optional)

Directional Controls: Continuous pressure switches

Control Voltage: 24 VDC

Safety Features:

Safety Nut:

Safety nut automatically engages if drive nut fails. Platform falls less than 13mm (1/2") when safety nut engages. Engaging safety nut trips the safety circuit.

Door Interlocks:

Solenoid powered deadbolt with monitoring circuit. Deadbolt stays in the locked position in the event of power failure. Battery backup provided.

Emergency Stop:

Stops platform travel and sounds audible alarm.

Emergency Operation:

Equipped standard with a manual lowering wheel. Optional battery powered lowering system available.

Finish:

Enclosure Frame & Mast Sides: Anodized aluminum

Sidewalls & Mast Cover: Baked powder finish on 16 gauge galvanized steel panels – Satin Grey

Doors: Baked powder finish on 16 gauge galvanized steel panels – Satin Grey or optional 5mm (3/16") thick clear or bronze tinted Plexiglas.

Optional Finishes: Extrusions and panels can be painted any color in the RAL chart.

Hydraulic Drive System: Technical Reference

Shaftway Platform Sizes:

- Compact
- Standard
- Mid-size
- Large

Exact clear platform dimensions are listed on pages 25-28.

Rated Load:

340 kg (750 lbs), with a safety factor of 5

Drive System:

Mains Power:

120 VAC single phase on a dedicated 15 amp circuit.
Outside N.A. - 208-240 VAC single phase on a dedicated 16 amp circuit.

Drive Type: Chained Hydraulic (Dual 5/8" ANSI 50 chains)

Standard Motor: 2.2 kW - 24V DC Motor: Continuous mains power and auxiliary battery power

Optional Power Supply: 2.2 kW - 24V DC from battery system, continuously charged by buildings mains power (suitable for low usage lifts only).

Speed:

5.2 meters (17 ft) per minute at full load

Operating Controls:

Keyed Controls: Keyswitch on call station and platform controls (optional)

Directional Controls: Continuous pressure switches

Control Voltage: 24 VDC

Safety Features:

Safety: Monitored slack chain device. Automatically engages if the drive chain fails. Platform falls less than 13mm (1/2") when the slack chain safety device engages.

Door Interlocks:

Solenoid powered deadbolt with monitoring circuit. Deadbolt stays in the locked position in the event of power failure. Battery backup provided.

Emergency Stop: Stops platform travel and sounds audible alarm.

Emergency Operation: Auxiliary Power System operates the lift in up and down direction.

Finish:

Enclosure Frame & Mast Sides: Anodized aluminum

Sidewalls & Mast Cover: Baked powder finish on 16 gauge galvanized steel panels – Satin Grey

Doors: Baked powder finish on 16 gauge galvanized steel panels – Satin Grey or optional 5mm (3/16") thick clear or bronze tinted Plexiglas.

Optional Finishes: Extrusions and panels can be painted any color in the RAL chart.

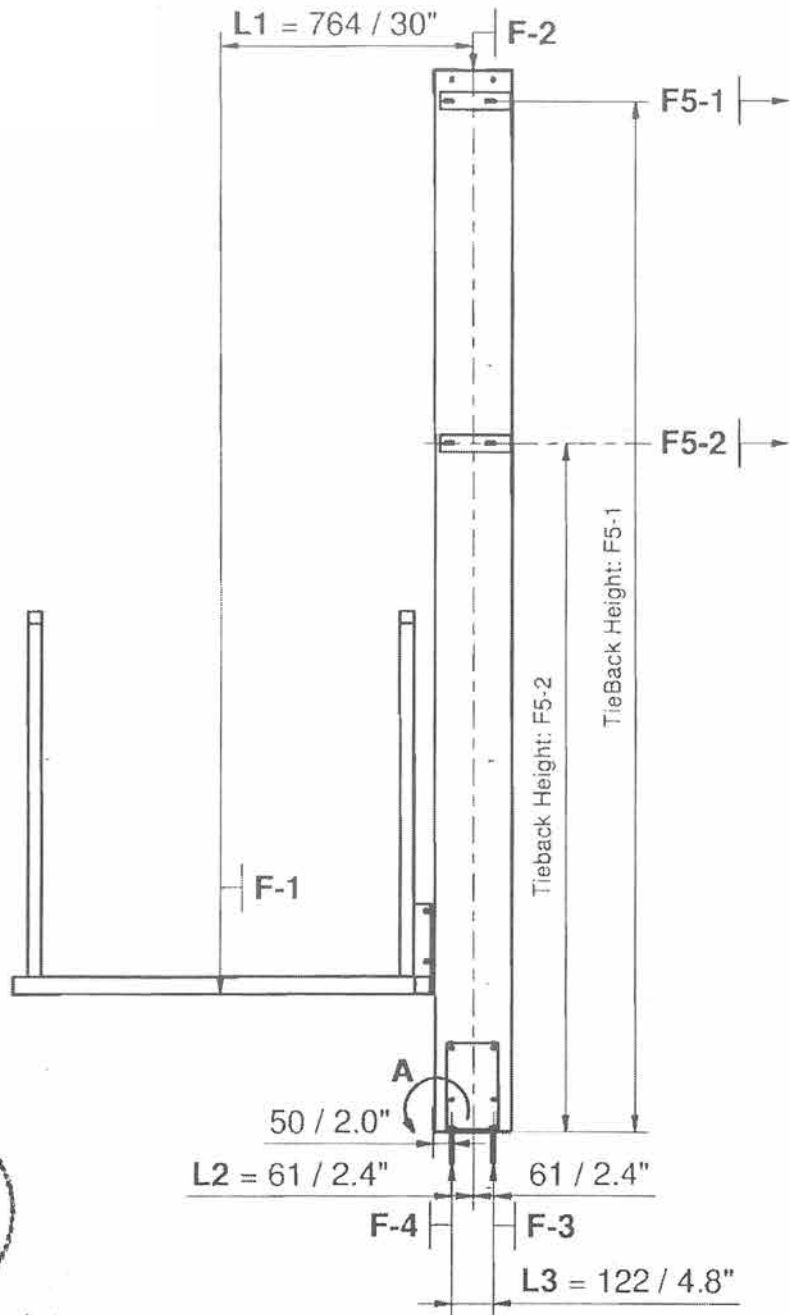

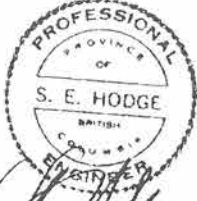
CHECKED
BY: 
[Signature] 10/1/09

Genesis Loading Diagram

Genesis Force Reactions (Imperial)

Lift Model	Mast Ht (in.)	Tieback Height		F1 lbs-f	F2 lbs-f	F3 lbs-f	F4 lbs-f	F5 lbs-f
		Ht-1 (in)	Ht-2 (in)					
42	68.4	65	43	1000	175	588	588	462
60	86.4	83	55	"	215	608	608	362
72	98.3	95	63	"	260	630	630	316
96	122.4	119	79	"	375	688	688	252
120	146.4	143	95	"	450	725	725	210
144	170.4	167	111	"	525	763	763	180
168	194.4	191	127	"	600	800	800	157
192	220.5	217	145	"	700	850	850	138
216	245.7	242	161	"	800	900	900	124

Genesis Force Reactions (SI)

Lift Model	Mast Ht (mm)	Tieback Height		F1 Newton	F2 Newton	F3 Newton	F4 Newton	F5 Newton
		Ht-1 (mm)	Ht-2 (mm)					
42	1737	1643	1092	4448	778	2616	2616	2055
60	2194	2101	1397	"	956	2705	2705	1610
72	2498	2405	1600	"	1157	2802	2802	1406
96	3108	3015	2007	"	1668	3060	3060	1121
120	3718	3625	2413	"	2002	3225	3225	934
144	4327	4234	2819	"	2335	3394	3394	801
168	4937	4844	3226	"	2669	3559	3559	698
192	5601	5507	3683	"	3114	3781	3781	614
216	6241	6147	4089	"	3559	4003	4003	552

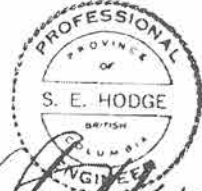
CHECKED BY:  10/1/09



Creating An Accessible World

 Printed in Canada
23376-D-DP

© Garaventa Lift. As we are continuously improving our products, specifications outlined in this brochure are subject to change without notice.

www.garaventalift.com

Authorized Garaventa Lift Representative